



TABLE OF CONTENTS

PROTEL PHONES, BOARDS, BATTERIES AND ACCESSORIES	1-4
QUORTECH / ELCOTEL PHONES, BOARDS, BATTERIES AND ACCESSORIES	5-6
GTE / QUADNUM PAYPHONE HOUSINGS	7-8
GTE / QUADNUM / PAYPHONE PARTS ESCROW PARTS AND COIN MECHS	9-10
ASD, VAULT AND CASH BOX	10
SECURITY, DIRECTION CARDS, ID TAGS AND VOL CONTROL	11
FACEPLATES	12
HANDSETS, ID TAGS AND VOLUME CONTROL	13
KEYPADS AND KEYPAD PARTS AND DIRECTION CARDS	15
WESTERN PAYPHONE HOUSINGS & PARTS	16-18
UNIVERSAL REPLACEMENT PARTS AND ACCESSORIES	19-20
HANDSETS	21
LOCKS AND KEYS	22
ENCLOSURES – AND PEDESTALS	23
ENCLOSURE MAINTENANCE	24
SIGNS	25
BINDERS, TDD, LINE SHARE DEVICES AND COIN COUNTERS	26
INMATE PHONE REPLACEMENT PARTS 	27
AIR MACHINE, OPTIONS, PARTS AND ACCESSORIES 	28
TECH SUPPORT AND REPAIR	29
WARRANTY AND REPAIR POLICY	30
RETURN AND REPLACEMENT POLICY	31
PRICING, CREDIT AND PAYMENT POLICY	32
CREDIT APPLICATION	33
PERSONAL GUARANTEE	34
CREDIT CARD TRANSACTION REQUEST	35
INDEX	INSIDE BACK COVER



Innovation is our business



- ◆ Factory-authorized Distributor Partner since 1989.
- ◆ Unmatched selection of OEM Protel® equipment.
- ◆ Experienced and Expert Tech Support IS FREE to North Atlantic customers.
- ◆ The only Protel-authorized and trained Repair Center in the country.

Complete Protel Phones
Ask About Refurb and Out of Service

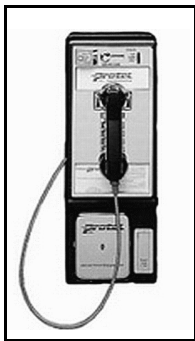

310 or 7000 Phone



7500 Phone



Ascension Phone (pg3)

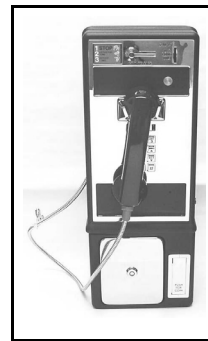

Semi Pub Phone

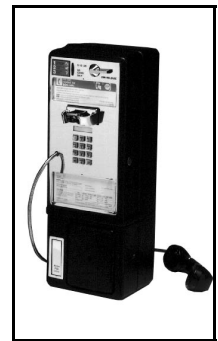

8000 Phone

Desktop Phones



PT7001
Credit Express

See Page 3



PT7051
Courtesy Plus

Limited supply of
7500 &
Semi Pub

New • Boards • Refurb

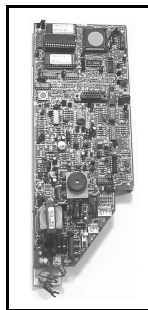

RF907
BB+ Board
(Refurb ONLY)

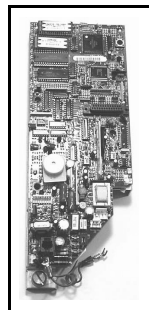

RF906
2000 Board
(Refurb ONLY)



PT220
310 Board



PT241
7000 Board



PT120
8000 Board

PROTEL® EQUIPMENT
COMPLETE PHONES, SMART BOARDS AND MODULES
[PHONES ARE PRICED WITHOUT LOCKS]

N.A. PART #	DESCRIPTION	PRICE
PROTEL® PHONES - QUADNUM - GTE STYLE / WESTERN		
	BB+ PHONE (refurb only)	CALL FOR LATEST PRICES ON <u>NEW</u> <u>AND</u> <u>REFURB</u>
	2000 PHONE (refurb only)	
	310 PHONE	
	7000 PHONE	
	4000 or 8000 PHONE (Western)	
	<ul style="list-style-type: none"> ◆ Refurb sold as available • Ask about Out of Service ◆ Phones configured to your specifications ◆ Mid Size Housing holds up to \$250 in coin • Ask your salesperson for details. 	
MORE PROTEL® COMPLETE PHONES		
CPH090	SEMI-PUB PHONE	395.00
CPH075	7500 PHONE w/ ECS II (while available)	395.00
	<ul style="list-style-type: none"> ◆ The Semi Pub phone is a less expensive, value engineered phone designed for indoor applications. ◆ The 7500 phone includes a credit card reader. 	
PROTEL BOARDS		
RF907	BB+ BOARD (refurb only)	CALL FOR LATEST PRICES ON <u>NEW</u> <u>AND</u> <u>REFURB</u>
RF906	2000 BOARD (refurb only)	
PT220/RF901	310 BOARD (new & refurb)	
PT241/RF900	7000 BOARD (new & refurb)	
PT120/RF905	4000/8000 BOARD (Western) (new & refurb)	
PROTEL MODULES		
PT250	COIN LINE MODULE	59.00
PT260/PT261	ECSII MODULE 310 / 7000	55.00
PT270	MARS MS-16 MODULE	59.00
PT280	BELL MODEM MODULE	55.00

PROTEL® EQUIPMENT

COMPLETE PHONES, SMART BOARDS AND MODULES (cont'd)



N.A. PART #	DESCRIPTION	PRICE
PROTEL® CREDIT EXPRESS & COURTESY PLUS PHONES		
PT7001	CREDIT EXPRESS PHONE, DESK	825.00
PT7002	CREDIT EXPRESS PHONE, DESK with TOLL RESTRICTOR	900.00
PT7011	CREDIT EXPRESS PHONE, WALL	869.00
PT7012	CREDIT EXPRESS PHONE, WALL with TOLL RESTRICTOR	945.00
PT7051	COURTESY PLUS PHONE, DESK	525.00
PT7052	COURTESY PLUS PHONE, DESK with TOLL RESTRICTOR	625.00
PT7041	COURTESY PLUS PHONE, WALL	575.00
PT7042	COURTESY PLUS PHONE, WALL with TOLL RESTRICTOR	675.00

ASCENSION BASE MODEL

STANDARD FEATURES:

- Three Level Volume Control
- English/Spanish voice prompts
- Next Call Button
- Coinco Coin Acceptor
- Black Vault Door



ASCENSION FULL-FEATURE INCLUDES

STANDARD FEATURES &

- Vacuum Fluorescent Display
- Speed dial
- Card reader
- Data port add-on option

The Ascension Charge-A-Port allows you to charge for Dataport usage!

N.A. PART #	DESCRIPTION	PRICE
PROTEL® ASCENSION PHONES		
	BASE MODEL w/COINCO	CALL FOR LATEST PRICING
	BASE MODEL w/ECSII	
	FULL FEATURED w/COINCO	
	FULL FEATURED w/ECSII	
ASCENSION OPTIONS & ACCESSORIES		
	CHARGE-A-PORT W/TOLL RESTRICTOR	150.00
	212A MODEM MODULAR BOARD	60.00
	COIN LINE OPERATION MODULAR BOARD	69.00
	COIN BOX ALARM SWITCH	26.60
<i>NOTE: Ascension phones priced without locks.</i>		

PROTEL® EQUIPMENT (cont'd)

PROTEL® PHONE ACCESSORIES

N.A. PART #	DESCRIPTION	PRICE
PT500	BATTERY NICAD 6 VOLT—FOR 200 BB+	6.95
PT505	BATTERY NICAD 4.8 VOLT—FOR 310, 2000, 4000, 7000, 8000	5.95
PT507	BATTERY METAL HYDRIDE 4.8 VOLT—FOR 310, 2000, 4000, 7000, 8000	5.95
PT506	BATTERY LITHIUM / RAM 3.6 VOLT—FOR 2000, 4000, 7000, 8000 (ROUND)	6.95
SK504	BATTERY LITHIUM / RAM 3.6 VOLT—FOR OLDER 310 (FLAT)	6.95
PT510	DOUBLE GONG RINGER & BRACKET FOR 7000	36.95
PT520	RJ11 PIGTAIL CONNECTOR	2.95
SP5800	VOLUME CONTROL BUTTON	8.95
PT405	ECS II COIN MECHANISM—STANDARD	95.00
PT406	ECS II COIN MECHANISM—MEDALIST (PAPER KICKER HARDWARE)	125.00
PT407	COIN TUBE FOR MEDALIST ECSII	6.95
PT540	U.L. SURGE PROTECTOR (PROTEL®)	16.95
PT550	KEYPAD ADAPTER CABLE 15F-25M PIN (PT551=15M-25F PIN CABLE)	21.95
PT306	2000/7000 SUPERDIAL TCU	26.95
PT310	200 BB+ SUPERDIAL KEYPAD ASSEMBLY	34.95
PT317	2000/7000 SUPERDIAL KEYPAD ASSEMBLY	38.95
HA505	HOOKSWITCH DIAL HOUSING INCLUDES: LEXAN DIAL HOUSING, HOOKSWITCH LEVER ASSEMBLY AND MAGNETIC SWITCH	19.00
UN287	NORTH ATLANTIC BATTERY CHARGER (PROTEL® / ELCOTEL® / BB+)	115.00

SEE PAGES 9-22 FOR COMPLETE LIST OF PROTEL PHONE PARTS

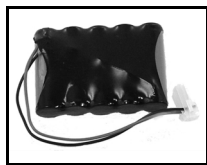

PT500
BB+ Battery

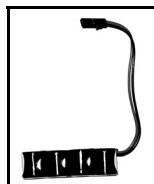

PT505
2000/4000/7000
Battery

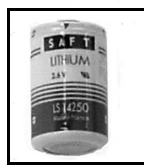

PT506
RAM Battery
2000/4000/7000



SK504
RAM Battery
310



PT520
Pigtail Conn.



SP5800
Volume Control



PT405
ECS II

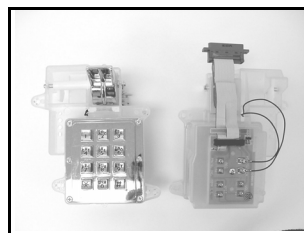

PT317
Superdial Keypad

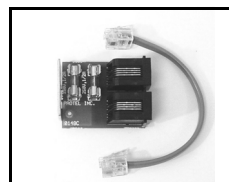

PT540
Surge Protector



UN287
Battery Charger



5500 & 5501 Phone
Western

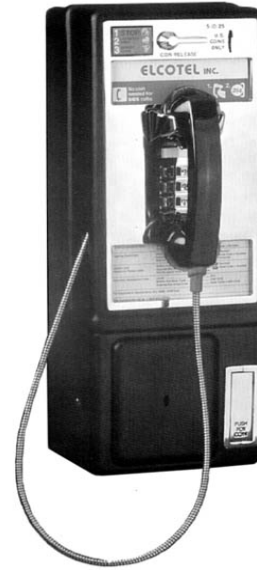

Series 5 Phone
Quadrum/GTE style

When you need expert repair and support and a complete supply of QuorTech® / Elcotel® products, North Atlantic delivers! Our experienced technical support, repair and sales staff is ready to serve you!

Call on us for all your Elcotel® supplies!

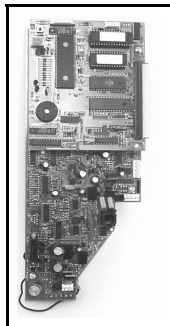

EL100
Series 5 Board

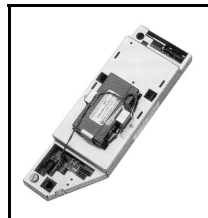

EL180
5502 Board

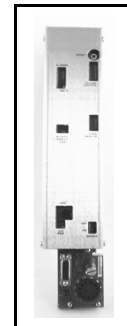

EL150 / EL175
5500/ 5501 Board

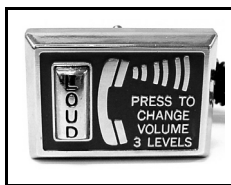

SP5800
Volume Control

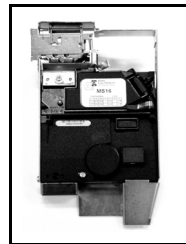

EL200
Mars MS16



EL105
Series 5 Battery

QUORTECH® / ELCOTEL® EQUIPMENT

QUORTECH® / ELCOTEL® BOARDS, PHONES & OPTIONS

N.A. PART #	DESCRIPTION	PRICE
ELCOTEL PHONES - GTE/QUADRUM		
CPSP100	QUORTECH/ELCOTEL SERIES 5 PHONE ♦ Also available Mid Size Housings that hold up to \$250 in coin. ♦ Ask your salesperson for details.	CALL FOR LATEST PRICES ON <u>NEW AND REFURB</u>
ELCOTEL PHONES - WESTERN		
	5500 OR 5501 (COIN LINE) WESTERN PHONE—20A MECH	CALL FOR LATEST PRICES ON <u>NEW AND REFURB</u>
	5500 OR 5501 (COIN LINE) WESTERN PHONE—22B MECH	
♦ Ask about New, Refurbished and out of service equipment ♦ Phones built to your specifications		
QUORTECH/ELCOTEL® BOARDS		
EL100/RF910	SERIES 5 BOARD—GTE (new & refurb)	CALL FOR LATEST PRICES ON <u>NEW AND REFURB</u>
EL180/RF914	5502 BOARD—GTE	
EL150/RF912	OLYMPIAN 5500 BOARD—WESTERN (new & refurb)	
EL175/RF913	OLYMPIAN 5501 BOARD—WESTERN (COIN LINE READY) (new & refurb)	

SEE PAGES 9-22 FOR COMPLETE LISTING OF REPLACEMENT PARTS FOR ELCOTEL® PHONES

QUORTECH® / ELCOTEL® ACCESSORIES, ADD-ONS AND UPGRADES

N.A. PART #	DESCRIPTION	PRICE
EL105	BATTERY 6 VOLT—FOR SERIES 5, 5500, 5501, 5502	5.95
EL106	BATTERY 6 VOLT EXTENDED WARRANTY—FOR SER5, 5500, 5501, 5502	8.95
EL200	MARS ELECTRONIC COIN MECHANISM	CALL
SP5800	SERIES 5 VOLUME CONTROL BUTTON FOR GTE / QUADRUM	8.95
EL415	PIGTAIL CONNECTOR	2.50
UN287	NORTH ATLANTIC BATTERY CHARGER (PROTEL® / ELCOTEL®)	115.00

QUADRUM/GTE STYLE HOUSING

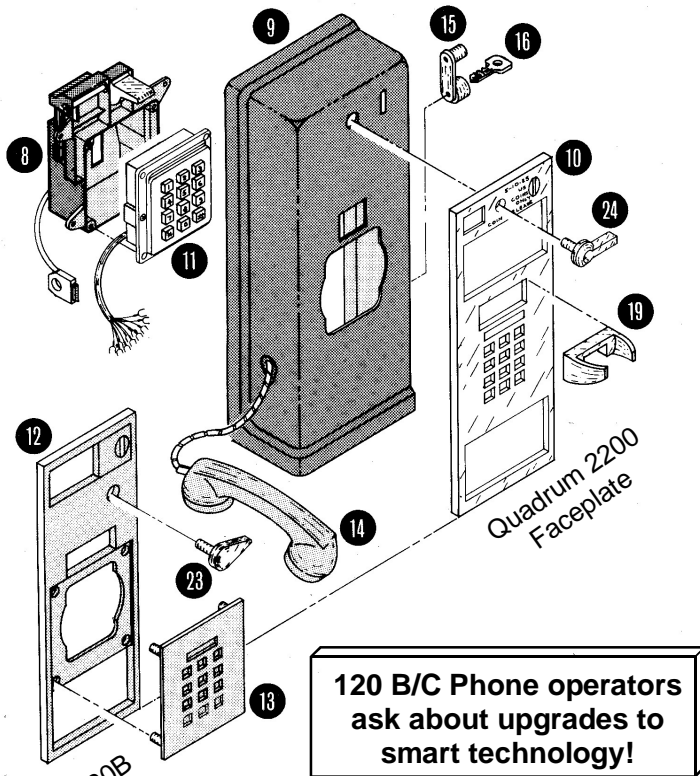

GTE 120B Faceplate

Quadrum 2200 Faceplate

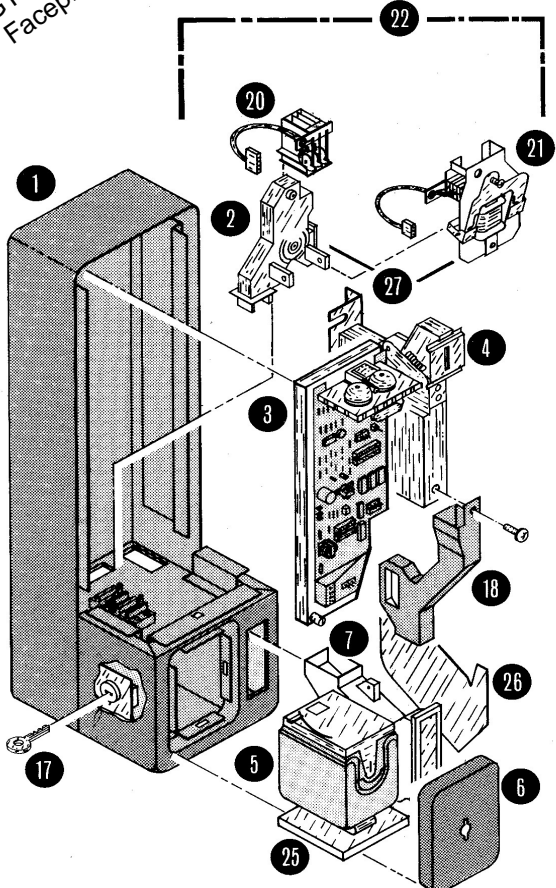

1	LOWER HOUSING
2	HOPPER
3	CIRCUIT BOARD (CHASSIS)
4	COIN MECHANISM
5	CASH BOX
6	VAULT DOOR
7	ASD
8	KEYPAD SHELL
9	UPPER HOUSING
10	FACEPLATE—QUADRUM
11	TCU (TOUCH CALL UNIT)
12	GTE FACEPLATE (120B)
13	KEYPAD ADAPTER PLATE
14	HANDSET
15	UPPER LOCK
16	UPPER LOCK KEY
17	LOWER LOCK & KEY
18	COIN RETURN CHUTE
19	CRADLE
20	TRIGGER
21	RELAY
22	ESCROW ASSEMBLY
23	GTE 120B COIN RETURN LEVER
24	QUADRUM COIN RETURN LEVER
25	VAULT LINER
26	ANTI-DRILL PLATE
27	RELAY THUMB SCREW

GTE AND QUADRUN HOUSINGS COMPLETE - UPPER - LOWER

N.A. PART #	DESCRIPTION	PRICE
GTE AND QUADRUN HOUSINGS		
CPH050	PROTEL® HOUSING WITH COINCO (ADD \$10 FOR ELCOTEL® READY)	245.00
CPSP100	SPECTRUM SELECT™ HOUSING WITH COINCO (ADD \$10 FOR ELCOTEL® READY)	265.00
LARGE CAPACITY MIDSIZE HOUSINGS		
CPSP100MP	SPECTRUM SELECT™ MID-SIZE HOUSING w/COINCO Holds up to \$250 in coin. Ask your salesperson for details.	295.00
<p>◆ Ask about Refurbished and out of service equipment</p> <ul style="list-style-type: none"> ◆ Phones built to your specifications ◆ Housings priced without locks 		
GTE AND QUADRUN UPPER & LOWER HOUSINGS		
UPPER HOUSINGS		
QU230	UPPER HOUSING - NO PARTS (includes rails)	CALL FOR LATEST PRICES ON <u>NEW AND</u> <u>REFURB</u>
SP-5000	UPPER HOUSING - SEMI COMPLETE - Includes: Faceplate, Lever & Linkage, 1-2-3 Info Plate, Cradle	
SP-5001	UPPER HOUSING - COMPLETE TO YOUR SPECIFICATIONS	
LOWER HOUSINGS		
QU225	LOWER HOUSING - NO PARTS	CALL FOR LATEST PRICES ON <u>NEW AND</u> <u>REFURB</u>
SP-0001	LOWER HOUSING - SEMI COMPLETE - Includes: ASD, Vault Spring, Vault Liner, Hopper Plate	
SP-0001	LOWER HOUSING - COMPLETE TO YOUR SPECIFICATIONS	
<p><i>We can quote upper & lower housings with the parts you specify. Refurbs available</i></p>		

SEE PAGE 18 FOR WESTERN HOUSINGS

GTE / QUADRUN EQUIPMENT

LOWER HOUSING PARTS

ESCROW PARTS (RELAY, TRIGGER & HOPPER), COIN MECHANISMS

N.A. PART #	DESCRIPTION	PRICE
QU510	RELAY—12 VOLT	26.95
SP1200	RELAY— 48 VOLT	26.95
SP1205	RELAY—SOLOSTAR (DUAL SOLENOID)	19.95
HA606	RELAY—PROTEL® (DUAL SOLENOID) REPLACES RELAY & HOPPER	32.95
SP1225	HOPPER ASSEMBLY	8.95
QU555	12 VOLT ESCROW ASSEMBLY (RELAY, TRIGGER & HOPPER)	45.95
SP1227	48 VOLT ESCROW ASSEMBLY (RELAY, TRIGGER & HOPPER)	42.95
SP1202	RELAY THUMB SCREW	.70
SP1201	RELAY COVER	.75
SP1250	TRIGGER ASSEMBLY (DOUBLE DIME)	6.95
SP1251	TRIGGER "A" STYLE	7.95
SP1253	TRIGGER COVER	.75
SP1300	COINCO ACCEPTOR—NO HARDWARE	28.50
SP1310	COINCO ACCEPTOR w/"B" HARDWARE ("A" HARDWARE SAME PRICE)	34.95
SP1380	COINCO ACCEPTOR w/PAPER KICKER	65.00
SP1307	COINCO ANTI-JAM PLATE	1.00
QU425	COINCO "B" GUIDE FORK	1.55
PT405	ECS II COIN SCANNER—STANDARD (PROTEL® ECSII MODULE ON PAGE 2)	95.00
PT406	ECS II COIN SCANNER—MEDALIST HARDWARE	125.00
PT407	COIN TUBE FOR MEDALIST ECSII	6.95

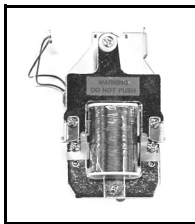

SP1200
48v Relay

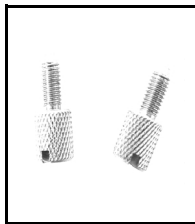

SP1202
Thumb Screws
(Relay)

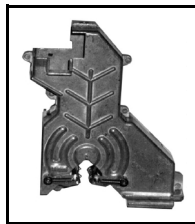

SP1225
Hopper

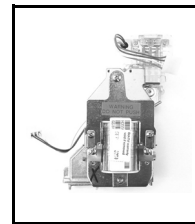

SP1227
Escrow Assy



SP1250
Trigger

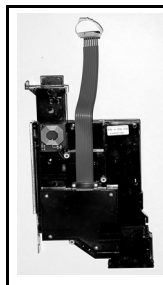

PT405
ESC II Coin
Scanner

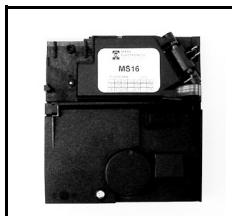

UN499
Mars MS16
Coin Scanner

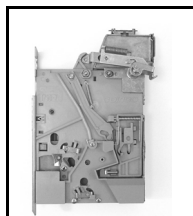

SP1310
Coinco w/
'B' Hardware

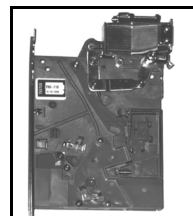

SP1380
Coinco w/
Paper Kicker

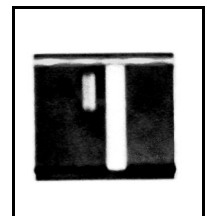

SP1307
Anti-Jam
Plate

GTE / QUADRUM EQUIPMENT (cont'd)

LOWER HOUSING PARTS

COIN MECHANISMS, ASD, VAULT & CASH BOX

N.A. PART #	DESCRIPTION	PRICE
UN499	MARS MS16 ELECTRONIC COIN MECHANISM ONLY (AVAILABLE FOR MEXICO—ASK FOR QUOTE)	165.00
EL209	STUFF BUSTER PAPER KICKER HARDWARE FOR MARS MS16	75.00
SP1375	COINCO PAPER KICKER LEAD IN CHUTE (NO COINCO)	29.95
SP1127	ANTI-STUFFING DEVICE—BRIGHT CHROME	7.50
SP1128	ANTI-STUFFING DEVICE —BRUSHED CHROME	10.95
SP1129	ANTI STUFFING DEVICE SCREW	.75
SP1125	ANTI-STUFFING DEVICE —CALSTAR TUFF STUF	24.50
SP1126	ANTI-STUFFING DEVICE —MAXI SECURITY	7.95
SP1308	PLASTIC COIN TUBE / REJECT CHUTE	1.95
SP1900	TERMINAL BLOCK	3.25
SP1902	TERMINAL BLOCK COVER	1.50
EL415	PIGTAIL CONNECTOR	2.50
SP9006	VAULT DOOR WITH 3 SIDED SECURITY	44.00
SP1001	VAULT DOOR—BLACK	12.50
SP1000	VAULT DOOR—STAINLESS STEEL	15.95
UN105	CASH BOX ONLY	3.50
SP1100	CASH BOX AND LID ASSEMBLY (LARGE COIN OPENING)	6.95
SP1102	CASH BOX LID ONLY (LARGE COIN OPENING)	4.95
QU586	PLASTIC CASH BOX LINER	3.95



SP1127
Chrome ASD



SP1126
Maxi ASD

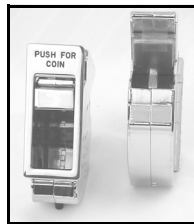

SP1125
CalStar ASD

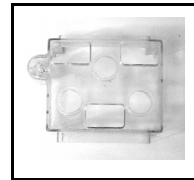

SP1902
Terminal Block Cover



SP1100
Cash Box w/Lid



WE556
Security Plus
Vault Door
(Front)

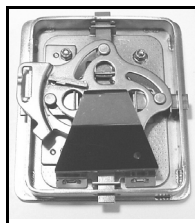

WE556
Security Plus
Vault Door
(Back)



SP9006
Vault Door—Security
(3 Side)



SP1000
Vault Door



EL209
Paper Kicker
for MS16

GTE / QUADRUM EQUIPMENT (cont'd)
LOWER HOUSING PARTS (cont'd)
SECURITY, DIRECTION CARDS & PLASTICS & ID TAGS

N.A. PART #	DESCRIPTION	PRICE
SP1103	SPECTRUM™ MID-SIZE CASH BOX AND LID ASSEMBLY	12.50
SP5950	"T" WRENCH FOR GTE / QUADRUM / WESTERN	1.50
UN476	SECURITY - COIN GUARD	24.95
SP9000	SECURITY - GTE ULTRA STAINLESS STEEL SECURITY SYSTEM	135.00
SP9001	SECURITY - PROTECTOR II SECURITY SYSTEM	165.00
LK9001	LOCK GUARDS	2.95

DIRECTION CARDS & PLASTICS & ID TAGS

N.A. PART # LOWER / UPPER	DESCRIPTION	PRICE
SP6025/SP6026	GTE 120B DIRECTION CARD	.50
SP6002/SP6027	GTE 120B CLEAR PLASTIC	.50
SP6050	TELEPHONE # CARD	.05
SP6051	TELEPHONE # PLASTIC WINDOW	.25
SP6000/SP6001	QUADRUM 2200 DIRECTION CARDS	.50
SP6002/SP6003	QUADRUM 2200 DIRECTION PLASTICS	.50
SP5825	ID TAG—1-2-3 ORANGE INFORMATION PLATE	2.75
SP5827	ID TAG—BLUE "PRESS # KEY FOR VOLUME" TAG	2.75
SP5828	ID TAG—YELLOW "NO INCOMING CALL" TAG	2.75
SP5800	VOLUME CONTROL BUTTON KIT	8.95



SP9000
GTE Ultra
Security



SP9001
Protector II Security
(Full stainless upper)



SP5950
'T' Key

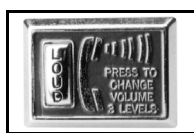

SP5800
Volume Control

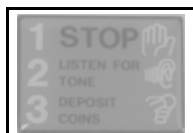

SP5825
Info Plate



SP5828
Info Tag

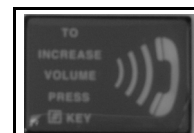

SP5827
Volume Tag

GTE / QUADRUM EQUIPMENT (cont'd)

UPPER HOUSING PARTS

FACEPLATES, LINKAGES & CRADLES

N.A. PART #	DESCRIPTION	PRICE
SP5412	FACEPLATE—GTE 120B SQUARE BUTTON ADAPTER PLATE	7.50
SP5411	FACEPLATE—GTE 120B HALF BUTTON ADAPTER PLATE	9.95
SP5410	FACEPLATE—GTE 120B BRUSHED CHROME	16.50
SP5405	FACEPLATE—QUADRUM / GTE CHROME	12.95
SP5400	FACEPLATE—STAINLESS STEEL—QUADRUM / GTE	18.95
SP5302	COIN RETURN LEVER—CHROME w/SCREWS (QUADRUM)	2.95
SP5300	COIN RETURN LEVER w/DOUBLE NUTS—CHROME	3.25
SP5305	COIN RETURN LEVER—GTE BRUSHED CHROME (FOR 120B—TEARDROP)	2.95
SP5303	COIN RETURN LEVER—ROUND KNOB (FOR QUADRUM)	3.95
SP5301	COIN RETURN LEVER—ROUND KNOB w/DOUBLE NUTS	3.95
SP5450	CRADLE—CHROME	3.75
SP5451	CRADLE—STAINLESS STEEL	6.95
SP5310	LINKAGE—STAINLESS STEEL W / ROUND KNOB	12.95
SP5314	LINKAGE—"K" STYLE (1 PIECE)	9.95
HA610	"D" LINKAGE KIT—NO LEVER (FOR HABITAT)	7.50

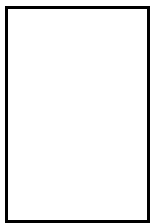

SP5410
120B Faceplate



SP5405
2200 Faceplate

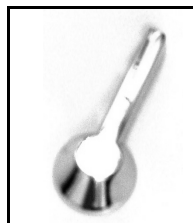

SP5302
Coin Return

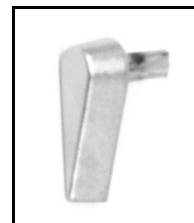

SP5305
GTE Coin Return

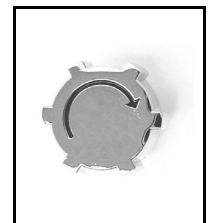

SP5303
Round Coin Ret



SP5450
Chrome Cradle



SP5314
1 Piece Linkage
(WORKS WITH ALL GTE/
QUADRUM STYLE HOUSINGS)

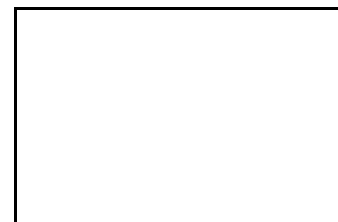

HA610
"D" Linkage

GTE / QUADRUM EQUIPMENT (cont'd)

UPPER HOUSING PARTS - HANDSETS

N.A. PART #	DESCRIPTION	PRICE
PREMIUM BEKTEL HANDSETS		
<u>SPADE CONNECTORS - XENOY PLASTIC - LANYARD CABLES</u>		
BKEL350	18" HANDSET	14.95
BKEL100	32" HANDSET	15.95
BKEL200	54" HANDSET	18.45
BKEL550	32" YELLOW HANDSET	16.95
BKEL500	54" YELLOW HANDSET	19.45
<u>MODULAR CONNECTORS - XENOY PLASTIC - LANYARD CABLES</u>		
BKEL300	18" MODULAR HANDSET	15.95
BKEL400	32" MODULAR HANDSET	16.95
BKEL526	54" MODULAR HANDSET	19.45
BKEL450	32" YELLOW MODULAR HANDSET (BLACK - RED - WHITE - WHITE WIRES)	17.95
BKEL525	54" YELLOW MODULAR HANDSET	20.45
VALUE PRICED HANDSETS		
<u>SPADE CONNECTORS - XENOY PLASTIC - LANYARD CABLES</u>		
UN2003	32" HANDSET—Value Priced	14.95
UN208	54" HANDSET—Value Priced	14.95
<u>MODULAR CONNECTORS - XENOY PLASTIC - LANYARD CABLES</u>		
UN2018	18" MODULAR HANDSET—Value Priced	13.95
UN2008	32" MODULAR HANDSET—Value Priced	13.95
UN20003	32" YELLOW MODULAR HANDSET— Value Priced (BLACK - RED - WHITE - WHITE WIRES)	14.95
SPECIALTY HANDSETS & HANDSET RETAINERS		
UN205	32" HANDSET w/CONFIDENCER	36.95
UN206	54" HANDSET w/CONFIDENCER	39.95
SP5500	HANDSET QUICK CONNECT	3.25
SP5506	HANDSET STRAIN RELIEF	1.50

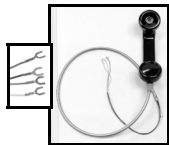

BKEL100
32" Spade
Handset

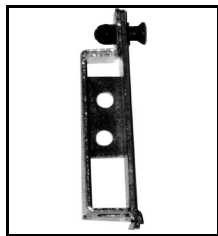

SP5500
Quick Connect

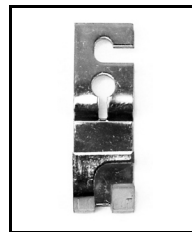

SP5506
Strain Relief

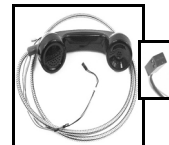

BKEL526
54" Modular
Handset

GTE / QUADRUM EQUIPMENT (cont'd)

UPPER HOUSING PARTS (cont'd)

KEYPAD ASSEMBLIES & KEYPAD PARTS

N.A. PART #	DESCRIPTION	PRICE
SP5100	ELCOTEL® NON-ARMOR (1 pc) KEYPAD—SPECTRUM™	36.95
SP5110	ELCOTEL® ARMOR KEYPAD—SPECTRUM™ (2 PC)	39.95
SP5150	INTELLICALL NON-ARMOR (1 pc) KEYPAD—SPECTRUM™	28.95
SP5151	INTELLICALL ARMOR KEYPAD—SPECTRUM™ (2 PC)	32.95
PT310	QUADRUM BB+ SUPERDIAL KEYPAD	34.95
PT317	PROTEL® 2000/7000 SUPERDIAL w/HOOKSWITCH ASSEMBLY	38.95
SP5125	PROTEL® 7000 NON-ARMOR (1 pc) KEYPAD—SPECTRUM™	32.00
SP5130	PROTEL® ARMOR KEYPAD—SPECTRUM™ (2 PC)	31.50
AE001	COSTSAVER KEYPAD—PROTEL®	24.95
AE002	COSTSAVER KEYPAD—ELCOTEL®	28.95
AE009	COSTSAVER KEYPAD—INTELLICALL	23.95

COSTSAVER KEYPADS (OTHER KEYPADS PICTURED ON NEXT PAGE)

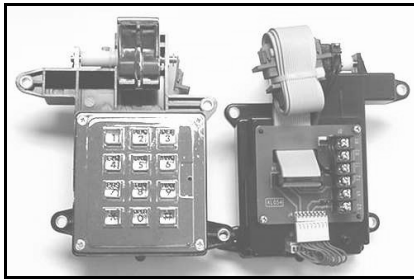

AE001
Protel Cost saver Keypad

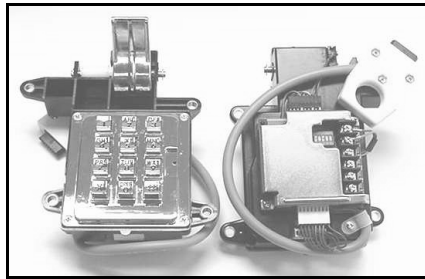

AE002
Elcotel Cost saver Keypad

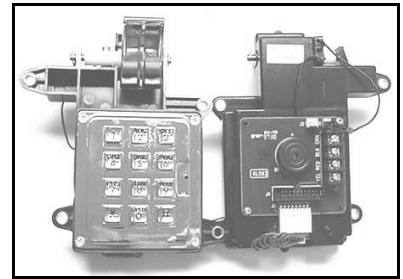

AE009
Intellicall Cost saver Keypad

KEYPAD PARTS

N.A. PART #	DESCRIPTION	PRICE
ELCOTEL		
QU3281	ELCOTEL® ARMOR DIAL TCU ASSEMBLY—QUADRUM	25.00
SP5102	ELCOTEL® KEYPAD CABLE	10.95
PROTEL		
PT306	PROTEL® 2000/7000 SUPERDIAL TCU	26.95
PT308	BB+ SUPERDIAL TCU	21.95
PT550	KEYPAD ADAPTER CABLE 15F—25M	21.95
PT551	KEYPAD ADAPTER CABLE 25F—15M	21.95
HA505	MAGNETIC HOOKSWITCH HOUSING	19.00

GTE / QUADRUM EQUIPMENT (cont'd)
UPPER HOUSING PARTS (cont'd)
KEYPAD PARTS (cont'd)

N.A. PART #	DESCRIPTION	PRICE
SP5163	LEVER—CHROME	3.95
CL111	HOOKSWITCH—METAL HOOKSWITCH W/MICRO & MAGNETIC SWITCH	9.95
SP5179	HOOKSWITCH—METAL ARMOR DIAL HKS WITH SUB MINI MICRO	9.95
SP5177	MICROSWITCH—SUB MINI	3.95
SP5176	MICROSWITCH—STANDARD	3.95
SP5172	MICROSWITCH STANDARD W/WIRES & BRACKET	4.95
SP5162	QUADRUM BLACK PLASTIC DIAL HOUSING W/LEVER & MIC	13.95
SP5165	KEYPAD SUBPLATE—BUTTONS—QUADRUM	9.95

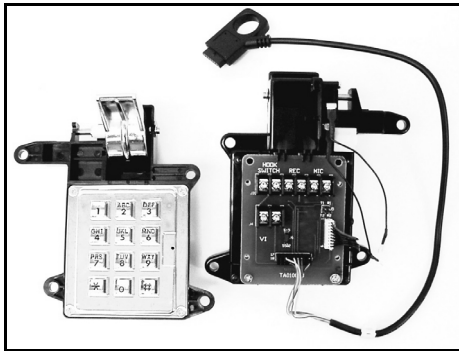

SP5100
 1 Piece Elcotel® Spectrum™ Key-

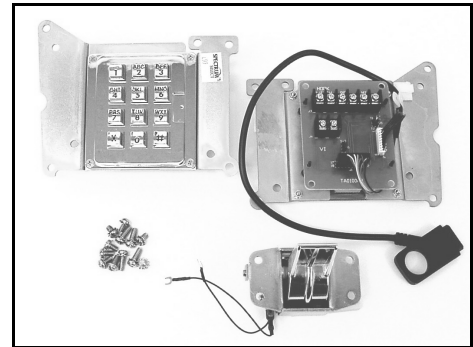

SP5110
 2 pc Elcotel® Spectrum™ Armor Key-

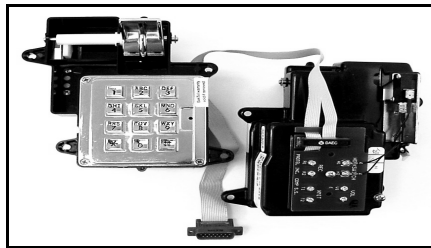

SP5128

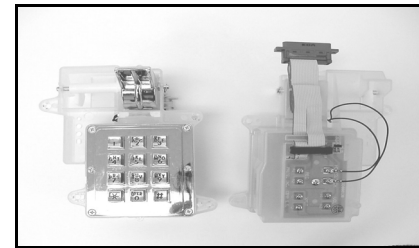

PT317

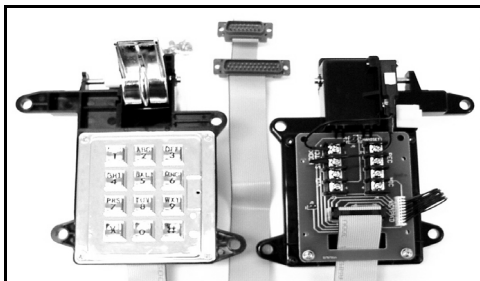

SP5125
 1 Piece 7000 Spectrum™ Keypad

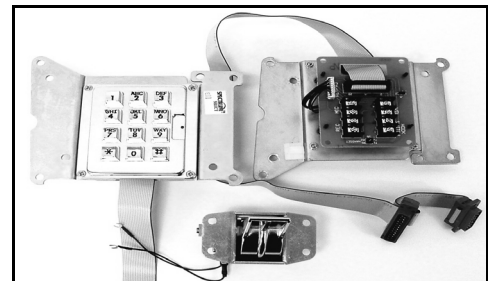

SP5130
 Protel® Spectrum™ Armor Keypad

**S
P
E
C
T
R
U
M™
K
E
Y
P
A
D
S**

WESTERN EQUIPMENT

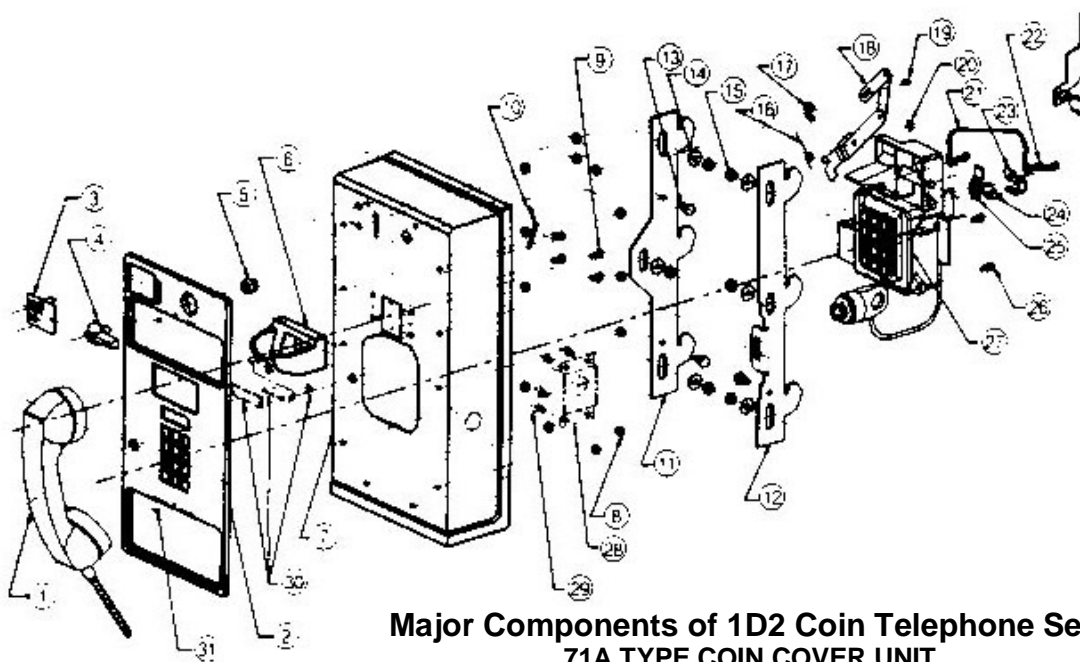

Major Components of 1D2 Coin Telephone Sets 71A TYPE COIN COVER UNIT

#	COMCODE	DESCRIPTION	#	COMCODE	DESCRIPTION
1	1005547012	G3AW-3 Handset Assembly	18	834080772	Link & Lever Assembly
2	840156301	Faceplate	19	996514188	Screw
3	840156327	Information Plate Assembly	20	997689179	Truarc
4	840358725	Shaft Handle Assembly	21	845455252	Ground Strap
5	540503486	Bushing	22	846407831	Screw
6	840358303	Switchhook	23	846403764	Cord Retainer Bracket
7	818926032	Cover Assembly	24	840157390	Fil. H.M. Screw, Quantity 4
8	900077371	Tread Forming Nut, Quantity 13	25	104187158	61C2-44 Coin Dial Unit (71A5) or
9	841067283	Pan Head Thread Rolling Screw (4)	25	104187141	61C1-44 Coin Dial Unit (71A4)
10	811553338	Detent Spring	26		29-Type Lock
11	811553288	Left Bolt	27	840155600	Knurled H. Soc. Cap Screw, Quant. 8
12	811553304	Right Bolt	28	102559986	D-1 80567 Kit of Parts
13	811553379	Stud Screw, Quantity 3	28	812169480	Window
14	842612996	Washer, Quantity 6		812169472	Cord Holder Bracket
15	802460493	Nut, Quantity 6		900577339	Fastener, Quantity 2
16	811557610	Spring	29	840153381	Screw, Quantity 2
17	997102132	Retaining Ring	30	818512030	Housing & Mounting Plate

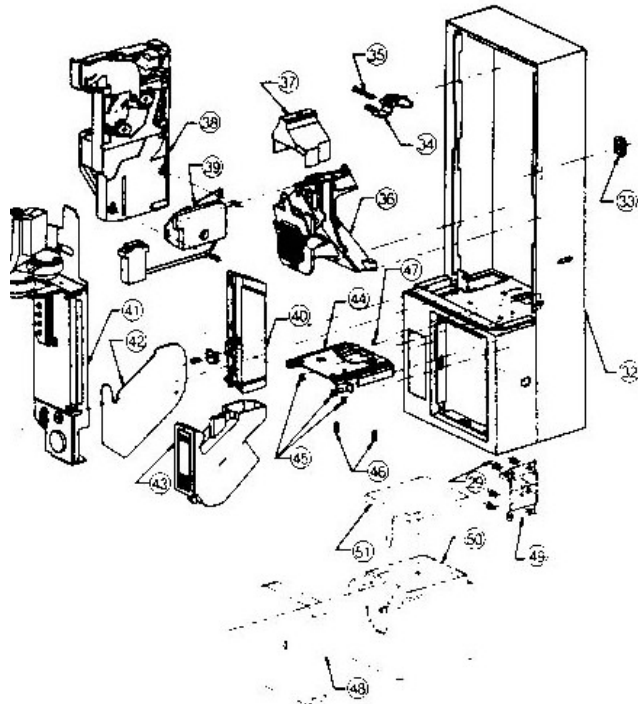

#	COMCODE	DESCRIPTION
31	812260081	Grommet
32	834081440	Locking Lever Assembly
33	996056404	Cotter Pin
34	101755668	1AA Coin Relay
35	811057835	Cover
36	106747868	22B Chute Assembly
38	811557305	Chute Return Assembly
39	105434518	32C Coin Chassis
40	812065530	Plate
41	812165462	Coin Return Assembly
42	100400613	1B Coin Rail
43	840696926	Hex Head Socket Screw
44	834082117	Screw, Special
45	801251349	Screw, RHM
46	101002145	2A Door
48	101903151	1C86 Coin Receptacle
49	101146546	1E Cover

WESTERN PARTS

NEW # / REFURB #	DESCRIPTION	NEW	REFURB
WESTERN LOWER HOUSING PARTS			
ESCROW PARTS (RELAY, 47A & HOPPER), COIN MECHANISMS, VAULT			
WE500 /	ANTI STUFFING DEVICE W/STRING CUTTER	7.50	———
/ RF120	COIN MECH—20A MECHANICAL	———	25.95
/ RF122	COIN MECH—22B ELECTRONIC	———	65.00
WE410 / RF125	COIN MECH—MARS WESTERN LPV226	———	QUOTE
WE510 /	COIN RETURN TUBE—METAL	3.85	———
WE511 /	COIN RETURN TUBE—PLASTIC	2.95	———
WE530 /	HOPPER	9.95	———
/ RF103	RELAY—1A	———	22.95
WE520 /	RELAY DUST COVER	1.00	———
/ RF111	47A TOTALIZER (COIN COUNTER)	———	12.00
WE545 / RF162	VAULT DOOR—BLACK	———	9.95
WE551 /	VAULT DOOR—STAINLESS STEEL	14.95	———
WE555 /	VAULT DOOR—WITH SECURITY	46.00	———
WE565	SECURITY VAULT DOOR PLUS	22.95	———
WESTERN UPPER HOUSING PARTS			
WE505 /	COIN RETURN LEVER	2.95	———
WE506 /	COIN RETURN LINKAGE	4.50	———
WE580 /	CRADLE—CHROME	4.25	———
WE585 /	CRADLE—STAINLESS STEEL	6.95	———
WE563 /	FACEPLATE—STAINLESS STEEL	16.95	———
WE565 /	FACEPLATE—CHROME	12.95	———
WE600 /	HANDSET RETAINER—2 PIECE THUMB SCREW TYPE	2.95	———
WE581 /	HOOKSWITCH TONGUE	2.95	———
SP5825/	ID TAG—ORANGE 1 - 2 - 3	2.75	———
SP5827/	ID TAG—PRESS # TO INCREASE VOLUME	2.75	———
WE304 / RF200	KEYPAD—61C ELECTRONIC (MODULAR)	36.95	30.95
WE305 / RF201	KEYPAD—61C ELECTRONIC (SPADE)	65.00	29.95
WE403 /	VOLUME CONTROL BUTTON	10.95	———
<ul style="list-style-type: none"> ◆ See page 20 for Cash Boxes ◆ See page 21 for Handsets ◆ See page 22 for Locks and Keys 			

WESTERN PARTS (cont'd) & WESTERN HOUSINGS DIRECTION CARDS—PLASTICS & SECURITY

NA PART #	DESCRIPTION	PRICE
WESTERN CARDS & PLASTICS		
SP6000	DIRECTION CARD—LOWER	.50
SP6001	DIRECTION CARD—UPPER	.50
WE610	DIRECTION PLASTIC—LOWER	.50
WE620	DIRECTION PLASTIC—UPPER	.50
WE575	PHONE # PLATE & CARD SET (KIT OF PARTS)	2.75
WESTERN SECURITY		
WE555	VAULT DOOR W/SECURITY	46.00
WE556	VAULT DOOR SECURITY PLUS— AVAILABLE WITH LOGO	22.95
WE900	W.E. ULTRA STAINLESS STEEL SECURITY SYSTEM (2 PC)	135.00
WE901	WESTERN PROTECTOR II SECURITY SYSTEM (2 PC ALL STAINLESS UPPER)	165.00
WESTERN HOUSINGS		
RF-980	WESTERN REFURB HOUSING	CALL FOR LATEST PRICING
WE200	WESTERN UPPER HOUSING —NO PARTS	
	WESTERN UPPER HOUSING—SEMI-COMPLETE—Includes: Cradle, Faceplate, Lever & Linkage, ID Tag	
WE201	WESTERN LOWER HOUSING—NO PARTS	
	WESTERN LOWER HOUSING—SEMI-COMPLETE—Includes: ASD, Vault Spring, Vault Liner, Hopper Plate	

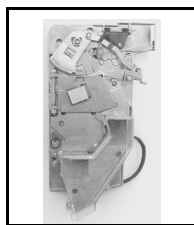

RF120
20A Coin
Mechanism

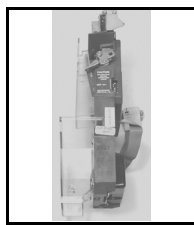

WE402
22B Coin
Mechanism

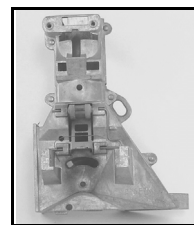

WE530
Hopper

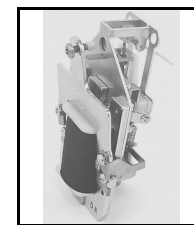

WE515
Relay

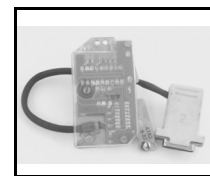

RF111
Totalizer

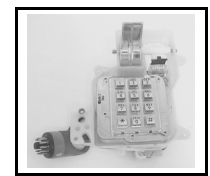

RF200
61C Electronic
Keypad



WE563
Faceplate



WE556
Security Plus Vault Door
(Front)

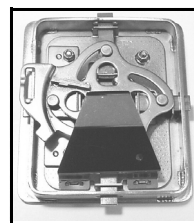

WE556
Security Plus Vault Door
(Back)



WE900
WESTERN
2-PC SECURITY

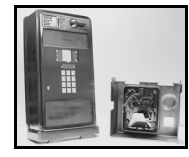

WE901
WESTERN
PROTECTOR II
SECURITY

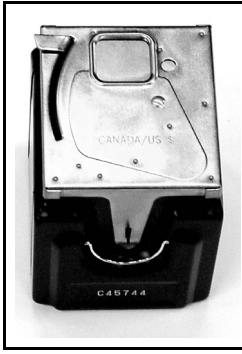

UN100
Cash Box w/Lid

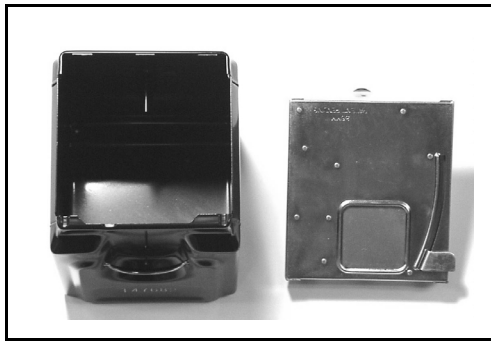

SP1100
Large Coin Cash Box w/Lid

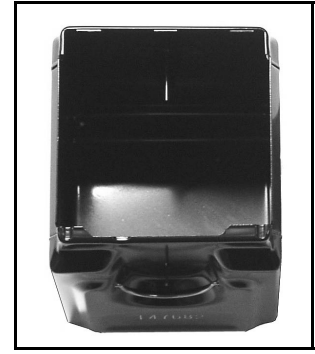

UN105
Cash Box Only

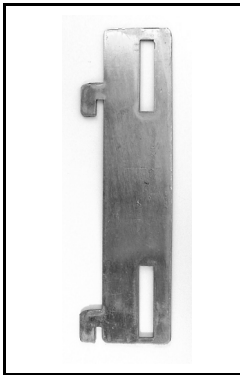

SP5952
Service Hanger

**WE STOCK ALL THE
PARTS YOU NEED!**

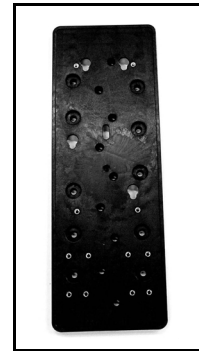

EN701
Backboard

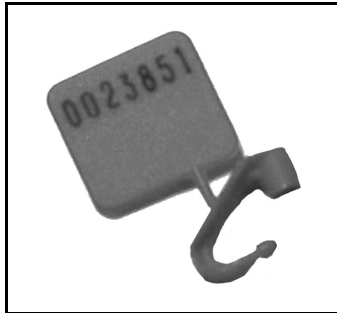

UN120
Cash Box Seal

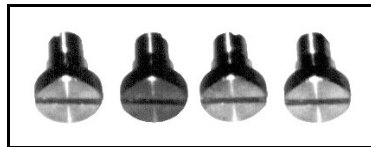

UN135
Security Studs



UN810
Ext. Data Port

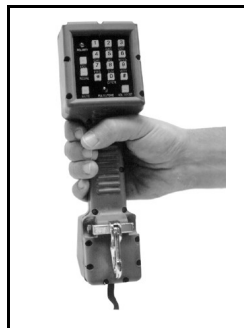

UN735
BECO Test Set



UN740
Lineman Test Set

UNIVERSAL REPLACEMENT PARTS (FOR MOST PAYPHONES)

N.A. PART #	DESCRIPTION	PRICE
UN105	CASH BOX ONLY	3.50
SP1100	CASH BOX AND LID ASSEMBLY (LARGE COIN OPENING)	6.95
SP1102	CASH BOX LID ONLY (LARGE COIN OPENING)	4.95
SP1103	MID-SIZE CASH BOX AND LID ASSEMBLY	12.50
UN120	CASH BOX SEAL - PLASTIC (NUMBERED) 250 / BAG	.08 EA
EN700	BACKBOARD—METAL	12.00
EN701	BACKBOARD—FIBERGLASS	14.95
SP5952	SERVICE HANGER FOR GTE/QUADRUM/WESTERN	2.50
SP5960	COIN BLOCKER	0.95
UN476	COIN GUARD	24.95
UN115	CASH BOX PULL RING	0.65
UN810	EXTERNAL DATA PORT ONLY (PRICE IS \$75.00 INSTALLED)	50.00
UN811	TOLL RESTRICTOR ONLY (FOR USE WITH EXTERNAL DATA PORT)	135.00
UN135	SECURITY STUDS (4 PER PACK)	2.95
UN735	1020 BECO TOUGH GUY TEST SET	190.00
UN740	LINEMAN TEST SET	89.95

If you need an item not pictured in this catalog, please call to inquire. We are constantly updating our product lines and inventory with items that may not have been included in this catalog version. Please let us know what you are looking for.

HANDSETS

N.A. PART #	DESCRIPTION	PRICE
PREMIUM BEKTEL HANDSETS XENOY PLASTIC—LANYARD CORD SPADE CONNECTORS		
BKEL350	18" HANDSET	14.95
BKEL100	32" HANDSET	15.95
BKEL200	54" HANDSET	18.45
BKEL550	32" YELLOW HANDSET	16.95
BKEL500	54" YELLOW HANDSET	19.45
MODULAR CONNECTORS		
BKEL300	18" MODULAR HANDSET	15.95
BKEL400	32" MODULAR HANDSET	16.95
BKEL526	54" MODULAR HANDSET	19.45
BKEL450	32" YELLOW MODULAR HANDSET (BLACK - RED - WHITE - WHITE WIRES)	17.95
BKEL525	54" YELLOW MODULAR HANDSET	20.45
VALUE PRICED HANDSETS XENOY PLASTIC—LANYARD CORD SPADE CONNECTORS		
UN2003	32" HANDSET—Value Priced	11.95
UN208	54" HANDSET—Value Priced	14.95
MODULAR CONNECTORS		
UN2018	18" MODULAR HANDSET—Value Priced	12.95
UN2008	32" MODULAR HANDSET—Value Priced	13.95
UN20003	32" YELLOW MODULAR HANDSET—Value Priced (BLACK - RED - WHITE - WHITE WIRES)	14.95
SPECIALTY HANDSETS		
UN205	32" HANDSET w/CONFIDENCER	36.95
UN206	54" HANDSET w/CONFIDENCER	39.95

CALL US FOR ANY SPECIAL HANDSET REQUIREMENTS

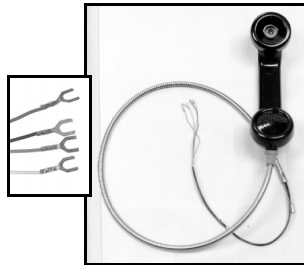

BKEL100
32" Handset

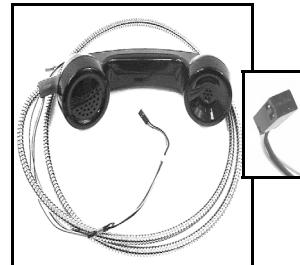

BKEL526
54" Modular Handset

LOCKS AND KEYS

N.A. PART #	DESCRIPTION	PRICE
GTE LOCKS		
LK0000	MEDECO LOWER LOCK – KEYED DIFFERENT—w/2 KEYS	27.95
LK0005	MEDECO LOWER LOCK – KEYED ALIKE—NO KEYS	26.95
LK0100	MEDECO UPPER LOCK—BJ0004—NO KEYS	16.95
LK0115	MEDECO UPPER LOCK—KEYED ALIKE—NO KEYS	19.95
LK0114	MEDECO UPPER LOCK—KEYED DIFFERENT—w/2 KEYS	27.95
LK0090	GENERIC LOWER LOCK—KEYED DIFFERENT—w/ 2 KEYS	18.95
LK0150	GENERIC UPPER LOCK—KEYED DIFFERENT—w/ 2 KEYS	12.95
LK2000	ABLOY LOWER LOCK – KEYED DIFFERENT—w/2 KEYS	32.95
LK2005	ABLOY LOWER LOCK – KEYED ALIKE—NO KEYS	28.95
LK2100	ABLOY UPPER LOCK—KEYED ALIKE—NO KEYS	24.95
LK2105	ABLOY UPPER LOCK—KEYED DIFFERENT—w/2 KEYS	29.95
WESTERN LOCKS		
LK3000	WESTERN REFURB LOCK—KEYED DIFFERENT—w/2 KEYS	16.50
	WESTERN REFURB LOCK—KEYED ALIKE	14.50
LK0400	MEDECO LOCK—KEYED ALIKE—NO KEYS	29.50
LK0405	MEDECO LOCK—KEYED DIFFERENT—w/2 KEYS	32.95
LK2400	ABLOY LOCK—KEYED ALIKE—NO KEYS	29.50
LK2405	ABLOY LOCK—KEYED DIFFERENT—w/2 KEYS	32.95
KEYS		
	KEYS ONLY	6.95
	KEYS PURCHASED w/LOCK	4.95
Call for refurbished lock pricing and availability.		

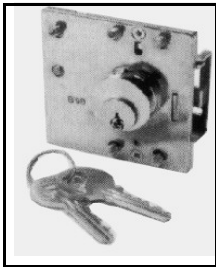

LK0000
Medeco Lower/GTE



LK0100
Medeco Upper/GTE



LK2105
Abloy Upper/GTE

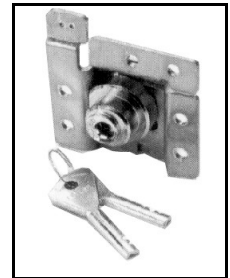

LK2000
Abloy Lower/GTE



LK0150
Generic Upper



LK0405
Medeco
Western Lower



LK3000
Western Refurb

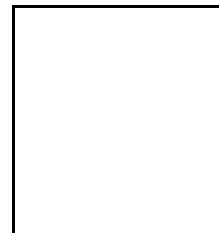

LK2405
Abloy
Western Lower

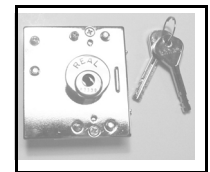

LK0090
Generic Lower

ENCLOSURES & PEDESTALS

INDOOR & OUTDOOR ENCLOSURES & PEDESTALS

N.A. PART	DESCRIPTION	PRICE
VALUE PRICED BOOTHS & PEDESTALS		
EN106	L31 STYLE BOOTH—BLUE (INCLUDES LIGHT)	120.00
EN107	L31 STYLE BOOTH—ANODIZED (NO LIGHT)	125.00
	L31 STYLE BOOTH & CENTER PEDESTAL—BLUE (INCLUDES LIGHT)	225.00
	L31 STYLE BOOTH & CENTER PEDESTAL—ANODIZED ALUMINUM	235.00
EN199	CENTER PEDESTAL—COSTSAVER	115.00
NORTH ATLANTIC PREMIUM BOOTHS & PEDESTALS		
Q10 BOOTHS		
EN110	Q10 BOOTH—BLUE (INCLUDES STAINLESS SHELF & LIGHT)	170.00
EN1077	Q10 BOOTH—SILVER (INCLUDES STAINLESS SHELF & LIGHT)	170.00
EN664	Q10 BOOTH & PEDESTAL—BLUE (INCLUDES STAINLESS SHELF & LIGHT)	295.00
EN665	Q10 BOOTH & PEDESTAL—SILVER (INCLUDES STAINLESS SHELF & LIGHT)	295.00
Q20 BOOTHS		
EN115	Q20 BOOTH—BLUE (INCLUDES STAINLESS SHELF & LIGHT)	245.00
EN1153	Q20 BOOTH—SILVER (INCLUDES STAINLESS SHELF & LIGHT)	245.00
EN628	Q20 BOOTH & PEDESTAL—BLUE (INCLUDES STAINLESS SHELF & LIGHT)	370.00
	Q20 BOOTH & PEDESTAL—SILVER (INCLUDES STAINLESS SHELF & LIGHT)	370.00
PEDESTALS		
EN199	CENTER PEDESTAL—COSTSAVER	115.00
EN200	CENTER PEDESTAL	135.00
EN220	DRIVE UP PEDESTAL	135.00
EN205	FLUSH TO WALL PEDESTAL	135.00
EN210	WALL MOUNT PEDESTAL	95.00
♦ ALL NORTH ATLANTIC PREMIUM BOOTHS INCLUDE LIGHTS ♦ ASK ABOUT CUSTOM COLORS OR LOGOS		
SPECIALTY BOOTHS		
EN1072	PLASTIC BOOTH—BLUE (INCLUDES LIGHT)	150.00
Call our sales team for a quote on booths not pictured in this catalog.		
WOODEN BOOTHS		
EN300	LIGHT OAK 16" w/SHELF	79.00
EN305	LIGHT OAK 24" w/SHELF	89.00
EN310	WALNUT 16" w/SHELF (DARK)	79.00
EN315	WALNUT 24" w/SHELF (DARK)	89.00

ENCLOSURES & PEDESTALS (cont'd)

ENCLOSURE MAINTENANCE

N.A. PART #	DESCRIPTION	PRICE
EN400	ENCLOSURE TOUCH-UP PAINT - BLUE	8.75
EN405	ENCLOSURE AND PEDESTAL TOUCH-UP PAINT - BLACK	8.75
EN411	ZEP ERASE VANDAL REMOVER (SPRAY CAN)	9.95
EN415	ANCHOR BOLT 1/2" X 3 3/4" FOR PEDESTAL INSTALLATION	1.50
EN420	TOGGLE BOLT FOR WALL MOUNT PEDESTAL INSTALLATION	.75
EN424	PIN-IN-HEAD SCREWS—3/8" (BEVELED)	.35
EN425	PIN-IN-HEAD ALLEN SCREWS—5/8" LENGTH (FLAT)	.35
EN430	PIN-IN-HEAD ALLEN SCREWS —1/2" LENGTH (BEVELED)	.35
EN435	ONE-PIECE PIN-IN-HEAD SCREWDRIVER	7.95
EN437	MAGNETIC SCREWDRIVER	13.95
EN438	MAGNETIC BITS	4.95

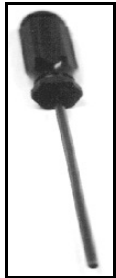

EN435
Pin-in-Head



EN415
Anchor Bolt



EN437
Magnetic Screwdriver

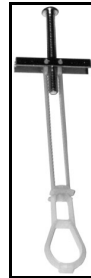

EN420
Toggle Bolt

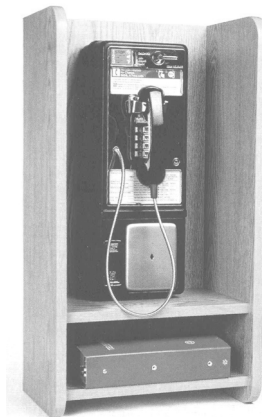

EN300
16" Light Oak w/Shelf



EN110
Q10 Booth



EN115
Q20 Booth



EN106
L31 Booth



EN1072
Plastic Booth
(800) 442-2388

**WE SUPPLY EVERYTHING
YOU NEED!**

ENCLOSURES & PEDESTALS (cont'd) PHONE SIGNS

N.A. PART #	DESCRIPTION	PRICE (Flanged)
EN440	12" X 12" BAKED ENAMEL "PHONE" SIGN (Bracket Style 14.95)	12.95
EN445	12" X 12" REFLECTIVE "PHONE" SIGN (Bracket Style 19.95)	17.95
EN450	18" X 18" BAKED ENAMEL "PHONE" SIGN (Bracket Style 28.95)	20.95
EN455	18" X 18" REFLECTIVE "PHONE" SIGN (Bracket Style 29.95)	24.95
OTHER SIGNS		
<ul style="list-style-type: none"> ◆ <i>Call Anywhere / .25 Min</i> ◆ <i>Phone Inside</i> ◆ <i>Phone From Car</i> ◆ <i>Local Calls .25</i> 		
ASK US ABOUT SIGNS NOT LISTED ON THIS PAGE		
EN050 & EN051	CORPORATE LOGO ENCLOSURE SIDE PANELS (LEFT & RIGHT) INSTALLS EASILY ON Q10, Q20 OR SIMILAR BOOTHS	CALL FOR QUOTE



EN050



EN051

Available in a variety
of corporate logos
and custom designs



Sign with
bracket



Sign with
flange

- ◆ **Flanged or bracketed styles available**
- ◆ **Baked Enamel or Reflective**
- ◆ **Double-sided graphics for increased visibility**

ENCLOSURES & PEDESTALS (cont'd) OUTDOOR DIRECTORY BINDERS

N.A. PART #	DESCRIPTION	PRICE
EN460	1-1/2" TURNED EDGE BINDER w/14" LANYARD w/DISK (ADDITIONAL SIZES AVAILABLE 2-1/2", 3-1/2", 4-1/2" FOR AN ADDITIONAL CHARGE)	19.50
EN461	1-1/2" STOW AWAY BINDER (ADDITIONAL SIZES AVAILABLE 2-1/2", 3-1/2", 4-1/2" FOR AN ADDITIONAL CHARGE)	42.95



Stow Away Binder

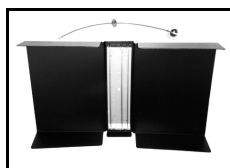

Lanyard Binder



UN802
TDD Shelf top Unit

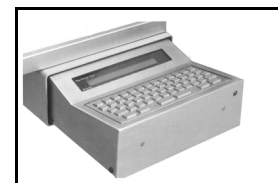

UN800
TDD Drawer Unit

TDD UNITS

N.A. PART #	ULTRA TEC PART #	DESCRIPTION	PRICE
UN805	MINICOM IV	TDD DESK UNIT	395.00
UN802	ST120	TDD SHELF TOP UNIT	695.00
UN800	M120	TDD DRAWER UNIT (120 CHARACTER DISPLAY)	895.00
UN801	M240	TDD DRAWER UNIT (240 CHARACTER DISPLAY)	1095.00
	M240FS	TDD OUTDOOR UNIT (240 CHARACTER DISPLAY)	1295.00

LINE SHARE DEVICES

N.A. PART #	DESCRIPTION	PRICE
UN700*	1x4 4 DEVICES HUNT 1 LINE / Priority port override option available	225.00
UN702	2x4 4 DEVICES HUNT 2 LINES / 911 disconnect option available	325.00
UN703**	2x8 8 DEVICES HUNT 2 LINES / 911 disconnect option available	395.00
UN704	4x8 8 DEVICES HUNT 4 LINES / 911 disconnect option available	550.00

* Priority port override for ATM or emergency phone applications.

** All port access option available. Polling computer can be programmed for remote access to phones through specific device ports.

COIN COUNTERS

Counts 2,700 coins per minute and it's portable!

N.A. PART #	SCAN COIN PART #	DESCRIPTION	PRICE
SC100	SC302	COIN COUNTER GOOD	899.00
SC105	SC303	COIN COUNTER w/ELECTRIC COIN SENSOR BETTER	950.00
SC110	SC313	COIN COUNTER w/AUTO-FEED BEST	1250.00

INMATE PHONE REPLACEMENT PARTS

ITEM#	DESCRIPTION	PRICE
KEYPADS		
CL600	PRISON PHONE KEYPAD	84.00
CL600V	PRISON PHONE KEYPAD W/ VOLUME CONTROL	89.00
SP-5800	VOLUME CONTROL BUTTON KIT	9.95
CRADLES		
SP-5450	CRADLE - CRADLE - CHROME (GTE)	4.25
SP-5451	CRADLE - STAINLESS STEEL (GTE)	6.95
WE580	CRADLE - CHROME (Western)	4.25
WE585	CRADLE - STAINLESS STEEL (Western)	6.95
<i>Western cradles are slightly smaller the GTE.</i>		
HOOKSWITCHES		
CL111	ARMORED HOOKSWITCH W/ MAGNETIC & MICRO SWITCHES	18.95
HANDSETS		
BKEL300	18" HANDSET - MODULAR	15.95
BKEL350	18" HANDSET - SPADE	14.95
BKEL400	32" HANDSET - MODULAR	16.95
BKEL100	32" HANDSET - SPADE	15.95
PT595W101	MODULAR CONNECTOR (GTE WIRING) RED-GREEN-YELLOW-BLACK	1.65
PT595W102	MODULAR CONNECTOR (GTE WIRING) RED-BLACK-WHITE-WHITE	1.65
<i>Please inquire about specialty length handsets or any parts not included on this list.</i>		



BKEL300
18" MODULAR HANDSET



SP-5800
VOLUME CONTROL
BUTTON KIT

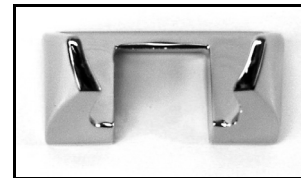

SP-5450
CRADLE - CHROME (GTE)

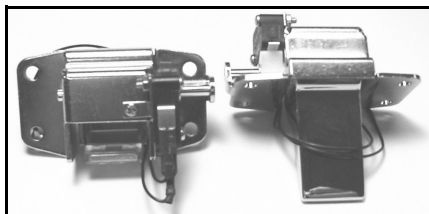

CL111
ARMORED HOOKSWITCH W/ MAGNETIC
AND MICROSWITCHES

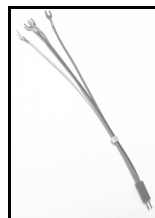

PT595W101
MODULAR CONNECTOR
(GTE WIRING)

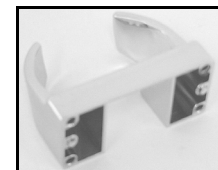

WE580
CRADLE - CHROME
(WESTERN)

AIR MACHINE, OPTIONS & PARTS

ITEM#	DESCRIPTION	PRICE
AM200	NORTH ATLANTIC AIR MACHINE AM200	1295.00
AM101	1.5 HP COMPRESSOR	235.00
AM102	BRASS FLOW VALVE	42.95
AM103	AIR INTAKE FILTER	14.50
AM106	25 FT HOSE	34.95
AM107	GAUGE & WHIP	26.95
AM109	INFITEC TIMER ONLY	54.95
AM113	18" BAKED ENAMEL FLANGED AIR SIGN	24.95
*AM101A	3 HP COMPRESSOR	325.00
*AM119	COIN IMPULSE COUNTER	19.95
<i>The above parts can be used on most air machines made by other manufactures.</i>		



** Optional on the AM200 North Atlantic Air Machine*

AM200 AIR MACHINE

\$ Add Revenue Cash Without Increasing Overhead \$



- ◆ Stainless Steel Construction
- ◆ Secure Interior Mounting
- ◆ High Visibility Decals & User Instructions
- ◆ Programmable Time & Fee Switch
- ◆ Tire Gauge Included on Hose
- ◆ Attractive & Stylish
- ◆ Steel Braided Hose
- ◆ **Two Year Warranty**

REPAIR SERVICE PRICING

BOARD MAKE	BOARD TYPE	PRICE*
PROTEL®	2000	50.00 + PARTS
	4000 / 8500	50.00 + PARTS
	7000 / 310	50.00 + PARTS
	CREDIT EXPRESS / COURTESY PLUS PHONE	75.00
	UPGRADE 2000 TO ALLOW FIRMWARE DOWNLOAD	30.00
	PROTEL® ECS II COIN MECH	15.00 + PARTS
ELCOTEL®	SERIES 5.0	50.00 + PARTS
	OLYMPIAN 5500/5501	50.00 + PARTS
	FIRMWARE CHIPS & SETS FOR ELCOTEL® BOARDS	Call for Prices
NO TROUBLE FOUND \$20.00		NOT REPAIRABLE \$20.00

* REPAIR PRICE IS FOR STANDARD EVALUATION AND REPAIR . SOME ADDITIONAL CHARGES WILL BE ADDED FOR ELECTRICAL SURGE DAMAGE, MISSING COMPONENTS OR PHYSICAL DAMAGE TO BOARDS OR COVERED HARDWARE.

SHIP REPAIRS TO: **NORTH ATLANTIC, INC.**
 301-A BROGDON RD
 SUWANEE, GA 30024



- ◆ Make sure to write the RPA number on the outside of the box
- ◆ For your protection, please ship all boards with insurance and tracking

CALL 800-442-2388 ext 312 TO GET RPA NUMBERS!

TECHNICAL SUPPORT

ELCOTEL® & PROTEL®

N.A. PART #	DESCRIPTION	PRICE
TS415	ELCOTEL® RATE FILE (E-MAILED OR ON DISK)	25.00
TS420	PNM PLUS SOFTWARE PACKAGE	299.00
TS440	PNM PLUS UPGRADE (REQUIRES VALID SERIAL # FROM PREVIOUS VERSION)	75.00
TS616	PROGRAM FEE	35.00
TS854	SERIES 5 ELCOTEL FIELD GUIDE (5501—TS852)	5.00
TS615	PROTEL® RATE FILE (E-MAILED OR ON DISK)	20.00
TS620	EXPRESSNET ROUTE MANAGEMENT SOFTWARE	N / C
TS621	EXPRESSNET III ROUTE MANAGEMENT SOFTWARE	1,495.00
TS561	PROTEL® UPMS 1200 BAUD MODEM PLEASE NOTE: MODEM SERIAL CABLE NOT INCLUDED	229.00
TS616	PROGRAM FEE - STANDARD PHONE	35.00
TS706	PROGRAM FEE - CREDIT CARD SWIPE PHONE	75.00
TS853	7000 PROTEL POCKET REFERENCE GUIDE (4000/8000—TS859)	5.00

WARRANTY AND REPAIR POLICIES

Warranty Policy

North Atlantic (NA) extends the manufacturer's limited warranty on specific products. In the case of refurbished products, NA will extend a warranty period specific to the used product at its discretion. On out-of-service equipment no warranty is extended and it is sold "As-Is".

New Payphones

New housings, new boards and new internal parts 2-Year Manufacturer's Limited Warranty*

Desk Top Payphones 1-Year Manufacturer's Limited Warranty*

All Other New Products, Parts & Subassemblies 2-Year Manufacturer's Limited Warranty*

Handsets 1-Year Manufacturer's Limited Warranty*

Refurbished Payphones

Refurbished Housings 6 months

new boards in refurbished housings 2-Year Manufacturer's Limited Warranty*

refurbished boards in refurbished housings 6 Months

All Other Refurb. Products, Parts & Subassemblies 6 Months

All warranties are from date of shipment to the CUSTOMER, to be free of defects in material and workmanship for the period indicated. NA will repair or replace the defective part, without charge for parts or labor for the duration of the warranty. The warranty does not cover defects caused by unreasonable use, abuse, improper handling and/or repackaging, unauthorized repair service and/or unauthorized replacement parts, vandalism, neglect, or damage by accident.

Repair Warranty Policy

North Atlantic (NA) warrants that covered equipment operates within the specifications published for the equipment and shall be free from defects in hardware and circuit boards for a period of ninety (90) days from the date of shipment or installation by NA. Six (6) additional months will be given on problems found and repaired on circuit boards, by NA.**

The CUSTOMER may return to NA, during the applicable warranty period at the CUSTOMER'S shipping expense, any product sold by NA to the CUSTOMER that is defective. NA shall return to the CUSTOMER, as promptly as possible, but no later than five (5) to (7) days after receiving a defective item as described above which is under warranty coverage, a working replacement or the original product repaired. The correction of such defective product(s) shall be at no cost to the CUSTOMER except for the expense of shipping the defective product(s) to NA which the CUSTOMER will pay. The cost of shipping repaired or replacement product(s) back to the CUSTOMER shall be paid by NA.

****Exceptions are Electrical Surges and Vandalism.**

NOTE: The MANUFACTURER will price any product repair that requires the product to be sent to the manufacturer for repair. NA reserves the right to charge an additional \$25 administration fee for repairs sent to the manufacturer.

***Limited Warranty Exceptions**

A warranty may be voided if any of the following should occur: lightning, power surge, fire, physical damage, improper packaging / handling, unauthorized repair or upgrade modifications, use of non-factory authorized components, removal of serial number or manufacturer date label, and atmospheric or caustic corrosion.

RETURN AND REPLACEMENT POLICIES

Return Authorization Policy

Any CUSTOMER needing to return equipment for credit, whether it is toward the purchase of new equipment, a credit to be put on CUSTOMER'S account or to receive a check in the amount of the credit, should follow the procedure below.

PLEASE NOTE: To receive a credit of any nature, the product(s) being returned must be received in our offices no later than sixty (60) days after purchase.

1. The CUSTOMER should contact their Sales Associate and provide:
Customer name, contact name, telephone number, billing address, and shipping address, description of items for return, quantity of items for return, and coordinate any specific instructions with your Sales Associate.
2. The Sales Associate will assign a Return Merchandise Authorization (RMA) number for the product.
3. The CUSTOMER shall return material in the original carton F.O.B., Suwanee, Georgia, freight prepaid, unless otherwise authorized, with the RMA number on the outside of the box and on the packing slip.
Packages without RMA numbers will take longer to process. Please return to our offices at:

**NORTH ATLANTIC, INC.
301-A BROGDON RD
SUWANEE, GA 30024**

4. Upon evaluation, North Atlantic (NA) management will determine the value of the returned product(s). Should the CUSTOMER agree to the value determined by NA, the valued dollar amount can be applied in the following manner:
 - A. towards the purchase of new equipment
 - B. a credit to be put on customer's account
 - C. a check issued for the credit

NORTH ATLANTIC WORKS TO PROVIDE A FAIR AND TIMELY RETURN FOR CREDITS. THOUGH WE CANNOT LIMIT CIRCUMSTANCES BEYOND OUR CONTROL, IT IS OUR GOAL TO COMPLETE THE PROCESS WITHIN TWO (2) WEEKS FROM THE TIME OF RECEIPT.

Advance Replacements and Missing Parts **

If a CUSTOMER is on open account with North Atlantic, Inc. their account will be billed for the price of the items being replaced until the defective merchandise is returned to NA, at which time a credit will be issued.

COD CUSTOMERS with orders **under \$100.00** will be shipped Net Upon Receipt. If merchandise is not received back by NA in 14 days, charges will be added to the next COD order.

COD CUSTOMERS with orders **over \$100.00** will be shipped by holding the Customer's credit card information (a completed and signed credit card form along with a copy of the card and the driver's license must be on file). If the merchandise is not received back by NA within 14 days, the Customer's credit card will be charged. If the Customer does not have a credit card, the Customer must overnight a check to NA. If the merchandise is returned within 14 days, NA will return the uncashed check along with a refund for the overnight charges up to \$15.50. The Customer must fax or mail verification of their overnight charges to NA. If the merchandise is not received back by NA within 14 days, the check will be cashed and this method of Advance Replacement will no longer be available to the Customer.

**** Please note that this policy is in effect for the items that prove to be defective within the first 30 days of purchase ONLY.**

< < THERE IS A 15% RESTOCKING FEE ON ALL PRODUCTS > >

PRICING, CREDIT AND PAYMENT POLICIES

Pricing Policy

All prices and specific products are subject to change at any time without notice. Prices in this catalog supercede all prices in previous catalogs.

Payment Terms

North Atlantic, Inc. (NA) offers our CUSTOMERS the following payment terms: Company Check, Net upon Receipt, or Net 30 Days. **Once approved**, payment of merchandise may be made by: cash in advance, wire transfer, cashier's check or company check. Thirty (30) day terms are available with guarantees.

New Accounts

New CUSTOMERS will receive shipments on a COD basis. Large initial orders will need to be prepaid or shipped COD certified check. **Until a credit application has been submitted and approved, all CUSTOMERS will remain on a COD basis; an order under \$500 will be sent COD/Company Check, an order over \$500 will be sent COD/Cashier's Check.** A credit application can be submitted for approval by North Atlantic (NA) at any time. If you are approved for credit, NA will notify you of the terms in writing. **Original applications must be received by NA for final approval. Allow 2 to 3 weeks for approval on any set terms.**

Customers with Open Accounts

If North Atlantic (NA) extends credit to a CUSTOMER, the CUSTOMER is expected to pay all invoices within the extended terms. If the CUSTOMER fails to make timely payments, NA will return the account to a strictly COD basis. Should an account fall past due, the CUSTOMER will be put on "Shipping Hold" until the account is paid in full. Should an account become seriously past due, NA will refer said account for collection. Invoices over 30 days old are charged 1 1/2% interest.

Credit Card Policy

All CUSTOMERS must complete and sign the credit card form and return it along with a copy of their Driver's License, and the front and back of their credit card for orders over \$1,000. This will be kept on file as the original signature card and will be referred to for future orders. COD CUSTOMERS can charge up to \$1000.00 (or one phone maximum) on a credit card order. Terms CUSTOMERS may charge up to the same credit limit established for their account. **Credit limits are set based on each individual case.**

Freight Policy

All orders are shipped F.O.B. shipping point, Suwanee, Georgia, unless otherwise stated. Shipments will be made freight collect or freight prepaid and added to the invoice. North Atlantic (NA) is not responsible for any shipping damage. Claims for damage must be submitted to the carrier. **NA reserves the right to quote the best shipping rates. The Sales Associate will notify the customer of ship quote before the processing of shipment upon request.**

NA Reserves the Right to charge a \$25 Fee for All Returned Checks



CREDIT APPLICATION

Thank you for taking the time to complete this form. It will enable us to give you the best service and complete satisfaction in processing this application for credit. **Please fill out this form completely.**

Company Name: _____
Business Address: _____
City, State, & Zip: _____
Shipping Address: _____
City, State, & Zip: _____
Phone No.: _____ Fax No.: _____ Year Established: _____
Check Type of Business: Individual Owner ___ Partnership ___ Corporation ___ Other _____
Soc Sec # / Tax ID: _____

Information of all General Partners, Corporation Officers and/or Individual Owner

Name: _____ Title: _____
Name: _____ Title: _____
Name: _____ Title: _____

Bank Reference

Name: _____ Name: _____
Address: _____ Address: _____
City, State, & Zip: _____ City, State, & Zip: _____
Phone No.: _____ Fax: _____ Phone No.: _____ Fax: _____
Account #: _____ Checking ___ Loan: ___ Account #: _____ Checking ___ Loan: ___

Names and Addresses of Current Suppliers and/or Creditors

Name: _____ Phone: _____ Fax: _____
Address: _____
Name: _____ Phone: _____ Fax: _____
Address: _____
Name: _____ Phone: _____ Fax: _____
Address: _____

Terms and conditions of open accounts: Goods sold and delivered to the purchaser shall remain the property of the vendor until paid in full. Said vendor reserves the right, and customer agrees to vendor's right, to take possession of the merchandise for which it has invoiced the customer upon default of payment.

BY SIGNING THIS CREDIT APPLICATION, YOU AUTHORIZE YOUR BANK TO RELEASE CREDIT INFORMATION TO NORTH ATLANTIC MARKETING, INC. ON YOUR ACCOUNT (FOR CREDIT PURPOSES ONLY).

- (1) The applicant will PAY IN FULL all invoices within terms.
- (2) The applicant HEREBY AGREES to pay interest at 1-1/2% per month (18% per year) on ALL PAST DUE AMOUNTS.

FOR FINAL APPROVAL, ORIGINAL SIGNATURES ARE NEEDED!

If corporation - Authorized officer(s) must sign below. If individual - Owner(s) must sign below.

Name: _____ Date: _____ Title: _____

Name: _____ Date: _____ Title: _____



INDIVIDUAL PERSONAL GUARANTEE

I, _____,
residing at _____

for and in consideration of you extending credit at my request to
(company) _____,

of which I am (title) _____,
hereby personally guarantee to North Atlantic, Inc. payment of any obligation of the company,
and I agree to bind myself to pay on demand any sum which may become due to North
Atlantic, Inc. by the company whenever the company shall fail to pay the same.

I understand that this signed document gives North Atlantic, Inc. the right to check my credit with Equifax Credit Inform Service or any service they may use.

It is understood that this guarantee shall be a continuing and irrevocable indemnity for such indebtedness of the company. I do hereby waive notice of default, non-payment and notice thereof and consent to any modifications or renewal of the credit agreement hereby guaranteed, and to all renewals of extension of credit. The undersigned guarantor agrees to pay, in the event the amount becomes delinquent and is turned over to an attorney or collection agency for collection, all collection fees and attorney fees accumulated in the collection of said debt.

APPLICANT SIGNATURE

APPLICANT SOCIAL SECURITY NUMBER

WITNESS SIGNATURE

DATE

**NOTE:
FOR FINAL APPROVAL,
ORIGINAL SIGNATURES
ARE NEEDED !!!!!**

